

2084 - Beta LED Pendant

proton™
assembly instructions

SONNEMAN®
A WAY OF LIGHT

Proton™ Product Information and Warnings

Important

- **Always disconnect the power before installing or replacing Luminaires and before cleaning or other maintenance.**
- **Consult a qualified, licensed electrician to ensure correct branch circuit conductor.**
Consulter un électricien qualifié pour vous assurer que les conducteurs de la dérivation sont adéquats.
- Please read all included assembly instructions and warnings carefully before installation. Contact Customer Service if you have any questions or concerns. Before installation, please confirm that the fixture is compatible with your supply voltage and dimming system, if present.
- LEDs are highly sensitive electronic devices, and must be treated with care. Do not open any factory sealed compartments, and avoid touching the LEDs with your hands or any object.
- Although all our fixtures are equipped with protective devices, LED electronic systems are vulnerable to power surges and supply variations. Do not install LED fixtures on the same circuit as any motors, appliances, or HVAC systems.
- Any mounting hardware is provided for your convenience and should be used with discretion. Always use the appropriate hardware for the mounting surface.
- Proton™ must be installed in dry locations ONLY.

Welcome to Proton™

A Proton configuration is built from LED luminaires, connecting hubs, connecting arms, and arm splitters. Illumination radiates from the glass globes. The connecting arms form a structural and electrical connection between the hubs, and are easily assembled by inserting the arm into the hub and are secured in place by a retaining set screw.

WHAT COMES IN THE BOX

Connectors - Contains the Connectors with attached cables

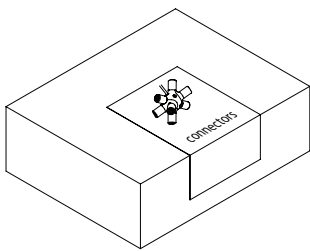

Power Feed - Contains the power feed for attaching the configuration to the outlet box and connecting to the power supply. Also includes a parts bag necessary for installation.

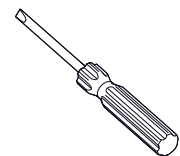
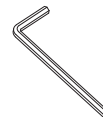
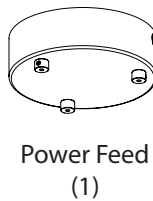
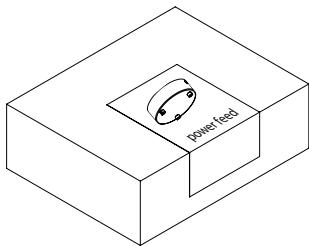

Light Globe Arms & Arms - Contains the luminaire arms, as well as the other arms and arm splitter

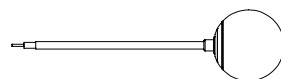
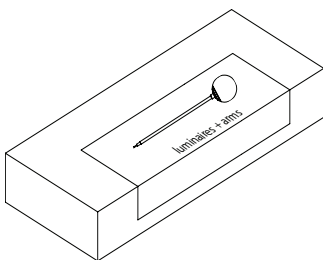

Proton Beta Pendant Assembly

Step 1 - Assemble Frame

- a. Fully insert the C3 Arms into the 'A' necks in the three Connectors (Fig. 2).
Fig 3 shows the different ports on the connector.
- b. After each Arm is inserted, install the M2 Set Screws into the ports of the Connectors, using the Small Hex Wrench provided, and tighten until they come in contact with the plastic caps on the Arms.
- c. Make sure that the 'C' ports are facing outwards. Completed step shown in Fig. 4.

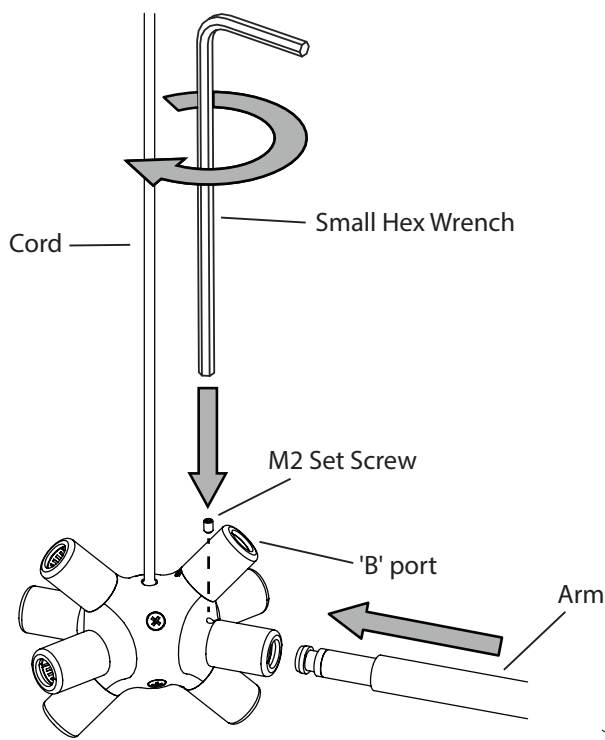
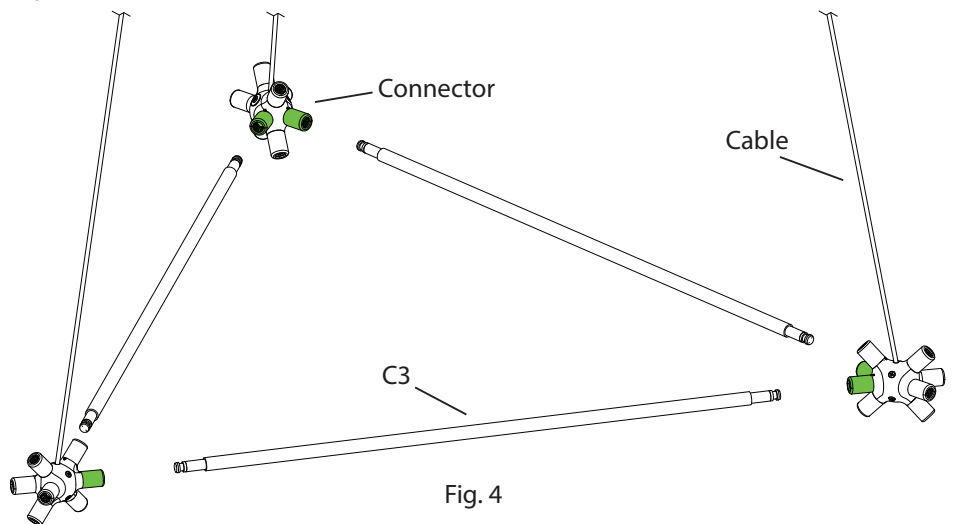
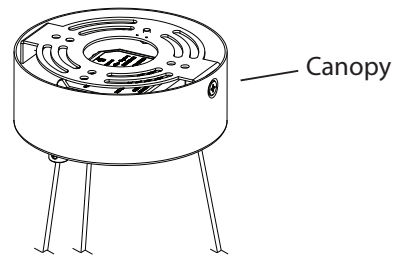
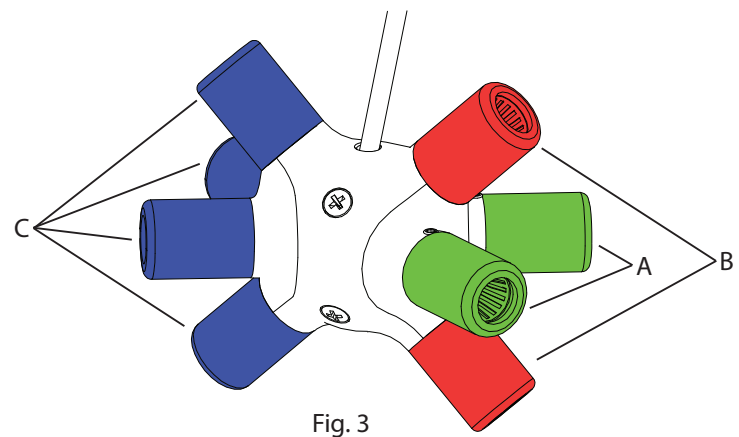
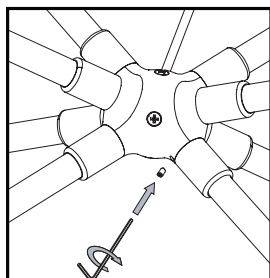

Fig. 2

IMPORTANT:
Be sure to install all M2 Set Screws to secure the Arms to the Hubs, as shown on page 5.



POWER SUPPLY AND POWER FEED INSTALLATION

Important

- Always disconnect the power before installing or replacing bulbs and before cleaning or other maintenance.
- Consult a qualified, licensed electrician to ensure correct branch circuit conductor.
Consulter un électricien qualifié pour vous assurer que les conducteurs de la dérivation sont adéquats.

Step 2 - Electrical Installation

- a. Shut off power to the outlet box (A).
- b. Feed the cords through the bushings (H). Determine height at which the pendant is to be hung. Use the screwdriver to loosen the slotted set screws (B). Adjust height of cords and tighten set screws. Reserve extra cord in the canopy (C). If shortening the cords is necessary, see Appendix A.
- c. Attach the mounting plate (D) to the outlet box (A), secure with outlet box screws (E).
- d. Make appropriate electrical connections using wire nuts:
 - I. Connect the LED driver's (F) live wire (black) to the live outlet box wire.
 - II. Connect the LED driver's (F) neutral wire (white) to the neutral outlet box wire.
 - III. Connect the canopy's ground wire (green or uncoated) to the ground outlet box wire. If no ground is present in outlet box, connect canopy's ground wire to the mounting plate (D) using the green screw (included).
 - IV. Connect fixture cords to driver output wires using lever nuts, as seen in Fig. 2 by pulling up on the lever for an empty slot (Fig. 3), inserting the wire, and pushing the lever back down to lock. The inner stranded conductor and the outer braided conductor on each cord must be connected to separate lever nuts, as shown in Fig. 2. Carefully place connections in canopy.
- e. Attach canopy (C) to the mounting plate (D), secure with canopy screws (G).

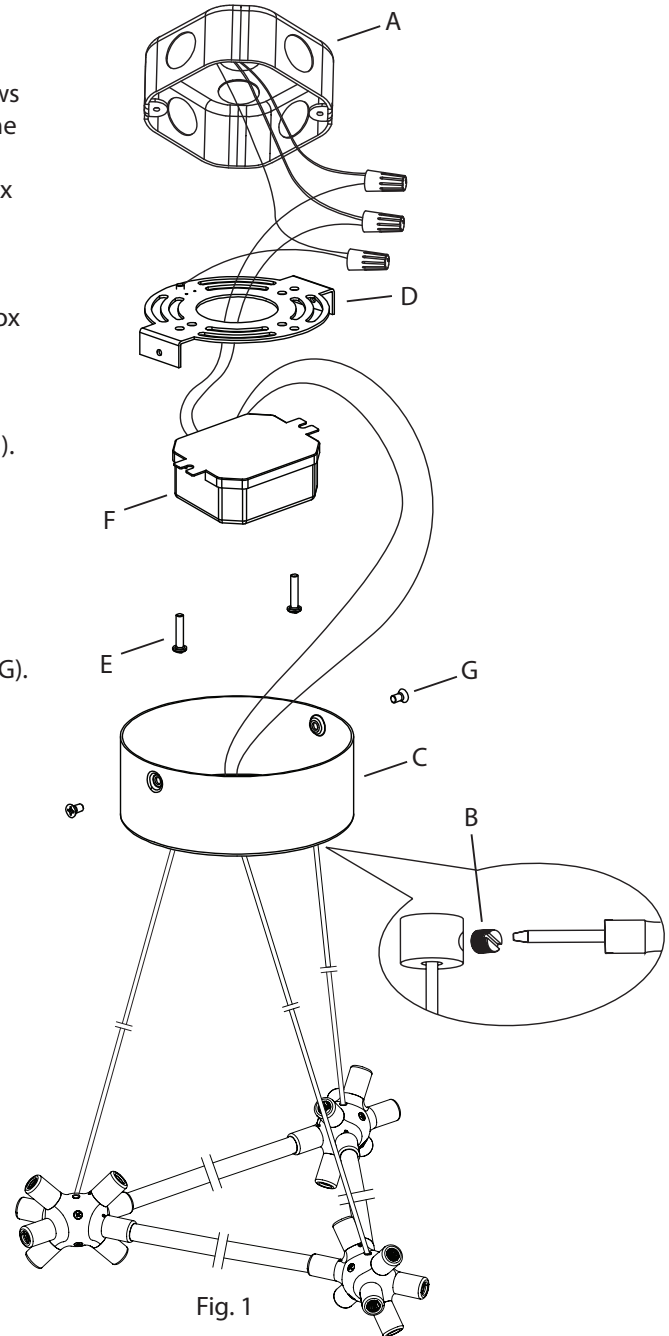

Fig. 1

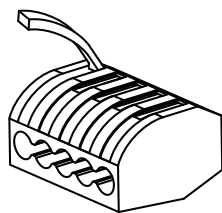

Fig. 3

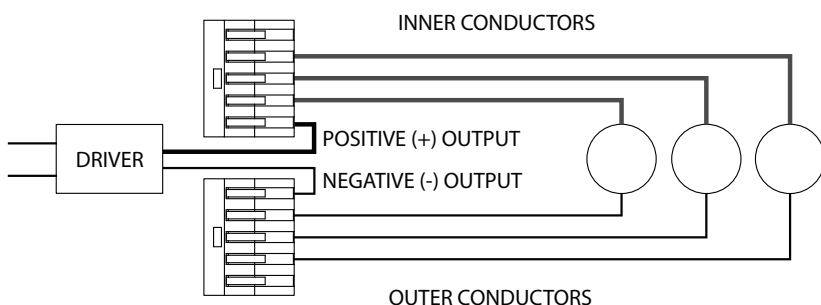

Fig. 2

Proton Single Pendant Assembly

Step 2 - Attach Lower Arms

- a. Insert the C2 Arms into an Arm Splitter about halfway.
- b. Slide those into the 'B' ports of the Connector until it reaches the end, then screw it in until tightened as shown in Fig. 5 & 6. This may require small adjustments to each arm until all are secure.

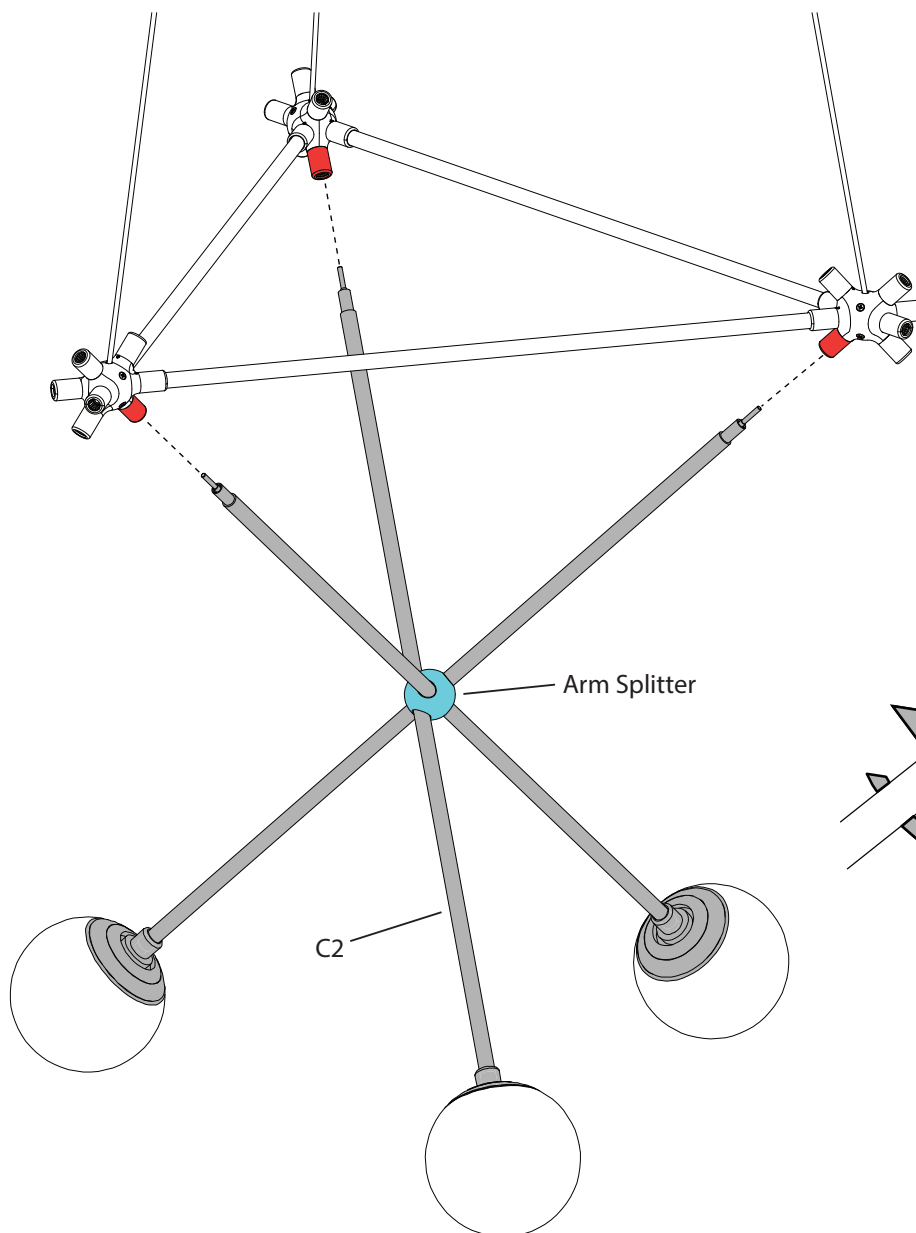

Fig. 5

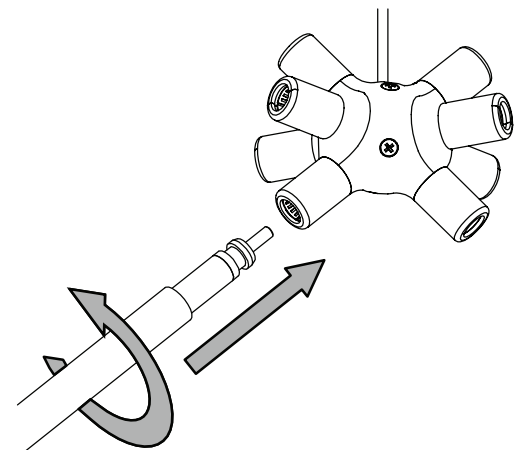

Fig. 6

Proton Single Pendant Assembly

Step 3 - Attach Upper Arms

- a. Repeat the steps of Step 2, but with the upward-facing 'B' ports on the Connectors, as shown in Fig. 7 & 8.

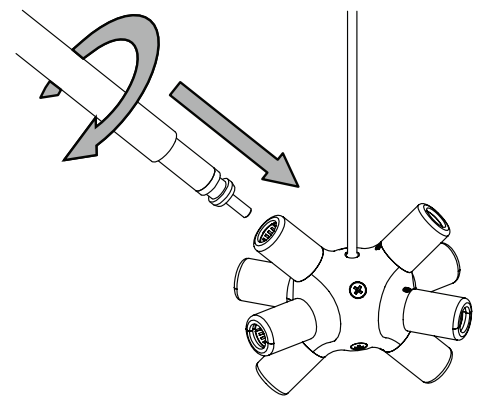
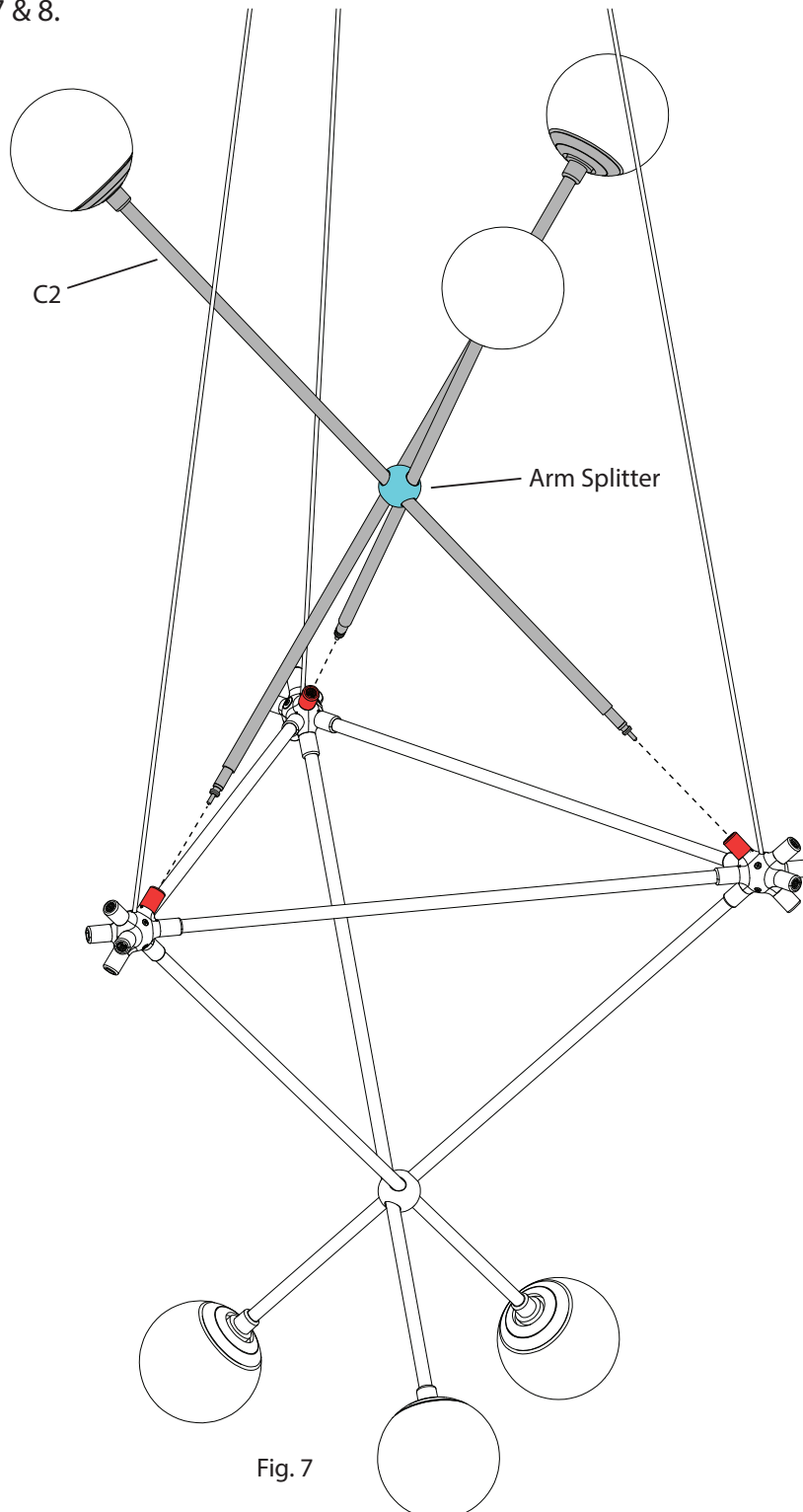

Fig. 8

Fig. 7

Proton Single Pendant Assembly

Step 4 - Attach Remaining Arms

- Connect the C1 arms into the 'C' ports of the Connector in the same manner as in Steps 2 & 3, as shown in Fig. 7 & 8.
- Restore power to the outlet box.

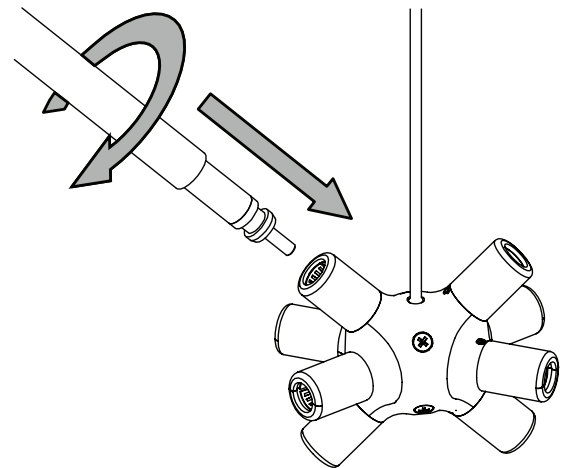

Fig. 10

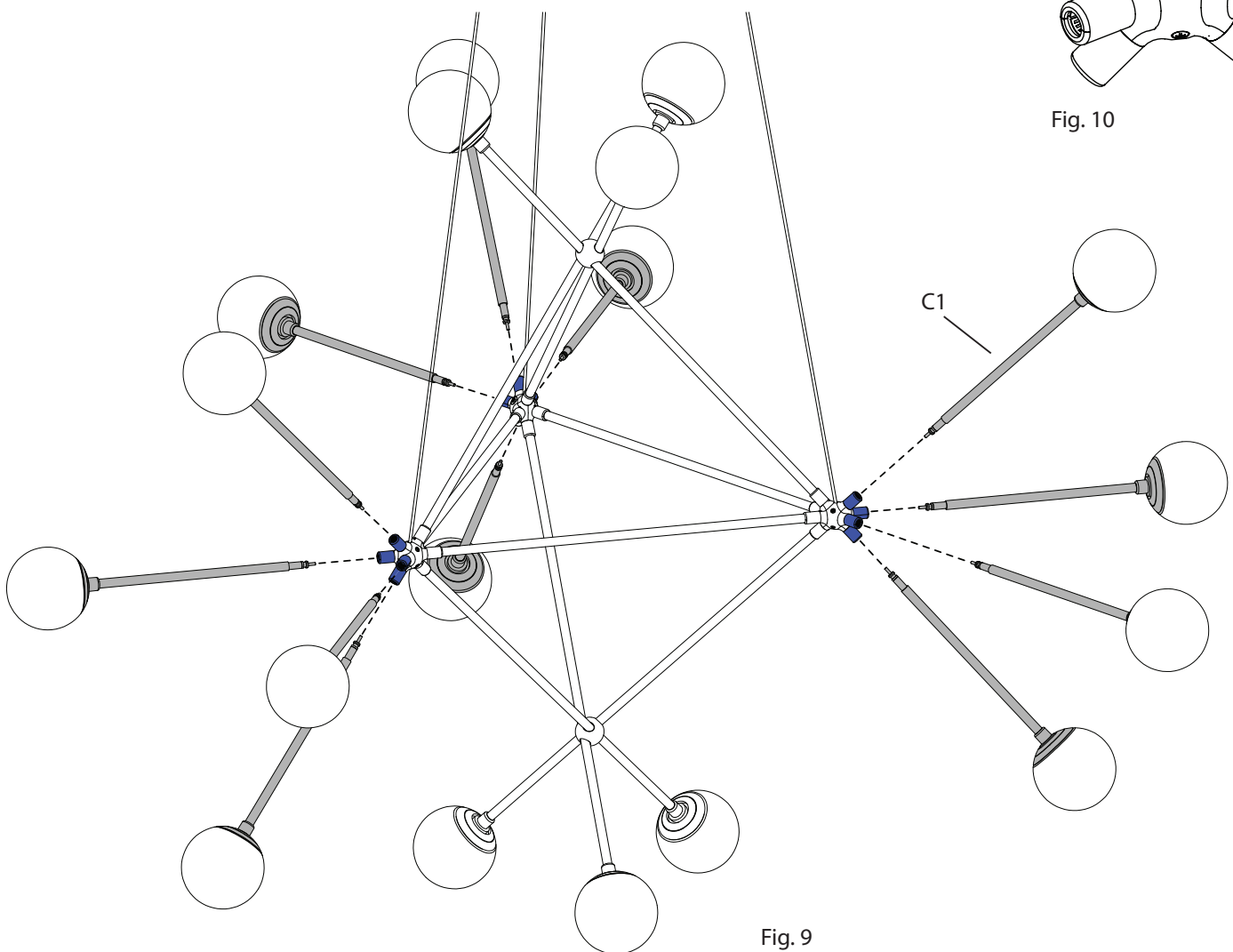
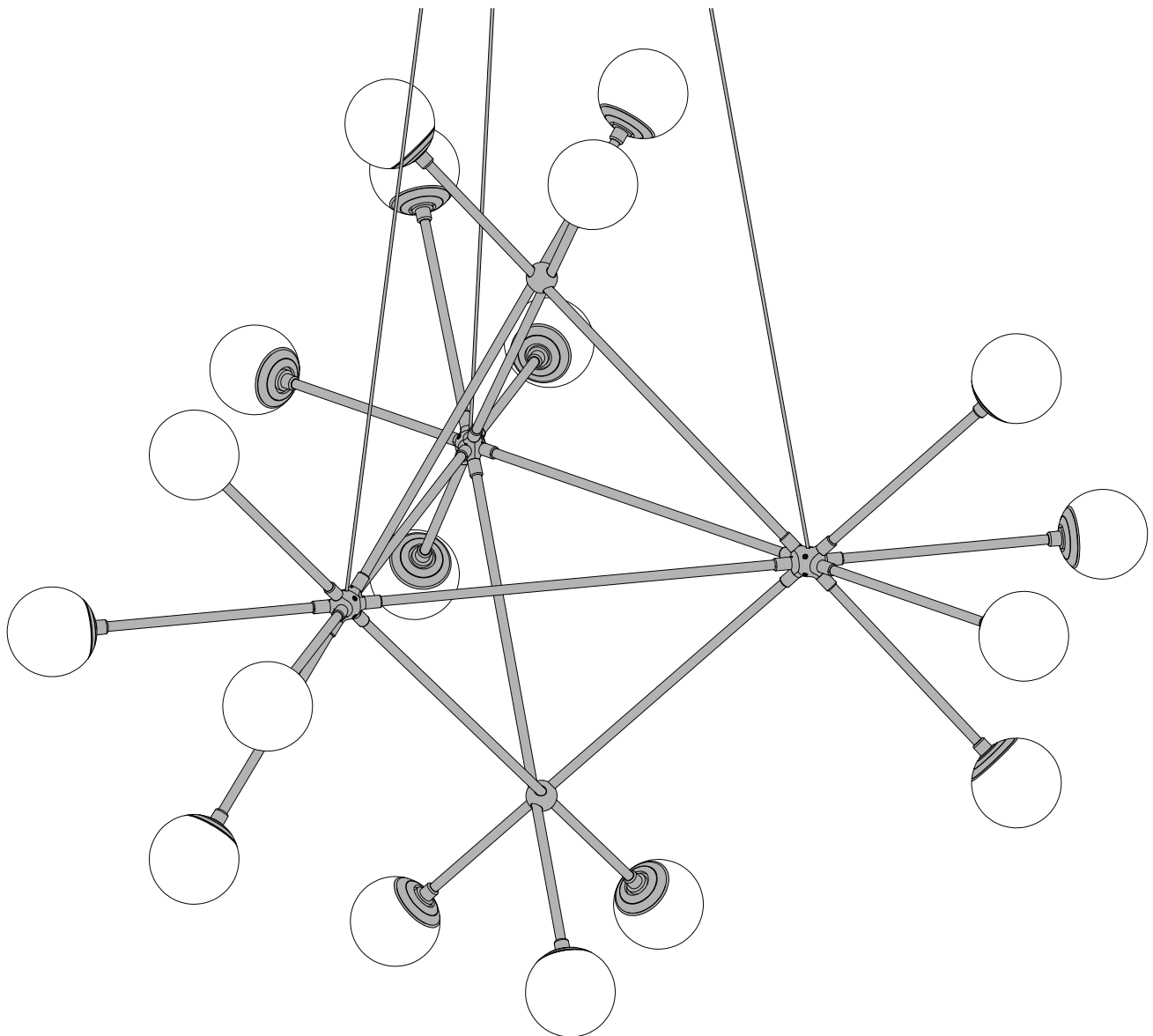

Fig. 9

COMPLETED ASSEMBLY



November 21, 2019

Coax Splicing Assembly Instructions

INSTRUCTIONS D'INSTALLATION

FAILURE TO FOLLOW THESE INSTRUCTIONS WILL VOID THE WARRANTY

Coaxial Power Cord:

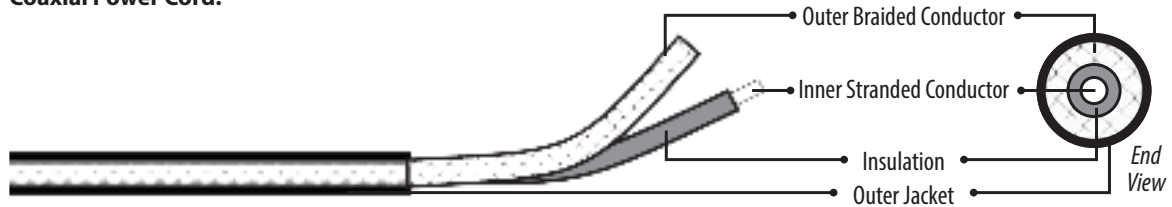

If field-cutting is required, please follow the below instructions:

1. Make a 1" slice along the length of the cord's outer jacket (Fig. 1). **CAUTION: Do not cut through the outer braided conductor.**
2. Carefully strip the outer jacket of the cord and keep the outer braided conductors intact (Fig. 1).
3. Slide the outer braided conductor back to create a bulge and reveal the inner stranded conductor (Fig. 2).
4. Bend the cord to create an opening through the bunched-up portion of outer braided conductor, then pull out the inner stranded conductor (Fig. 3)
5. Twist together the outer braided conductor to form the negative wire of the fixture, then strip 5/8" off the end of the inner stranded conductor to form the positive wire of the fixture (Fig. 4).
6. Re-splice all power cords.

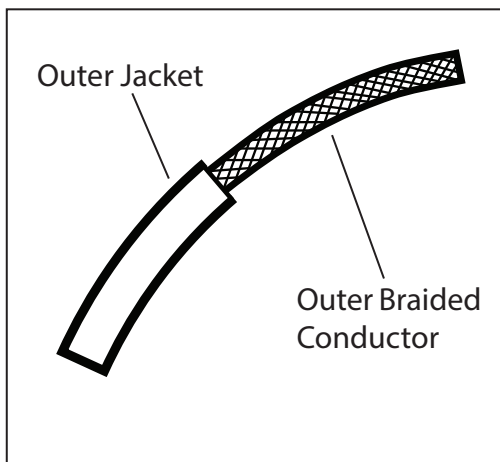

Fig. 1

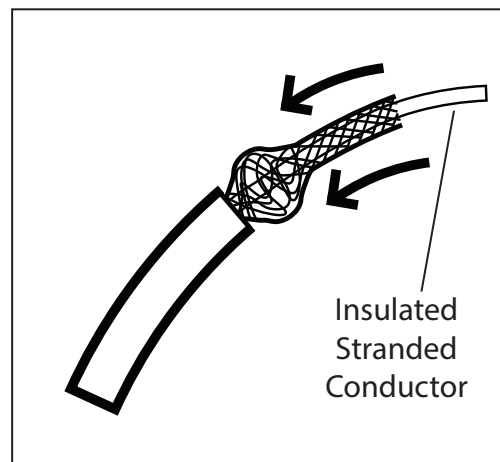

Fig. 2

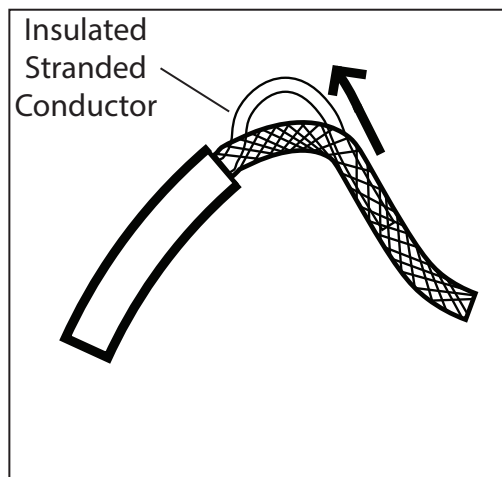

Fig. 3

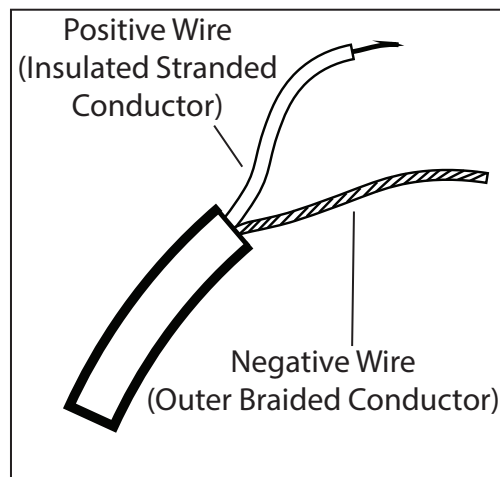

Fig. 4