

INSTALLATION INSTRUCTIONS

For Model 1432

READ AND SAVE THESE INSTRUCTIONS

HANGING THE MIRROR

1. Carefully unpack the new mirror and lay out all the parts on a clear area. Take care not to lose any small parts necessary for installation. Fig. 1
2. Take out the two arms and unscrew the decorative knob(C), then Install the two arms to the frame with the Allen wrench (included.) (PART#WRH-L-M8).and screw back the decorative knob(C).Fig 2
3. Locate a suitable place for the mirror on the wall.
4. Unscrew the two set screws (D) and lift up the decorative cover (E) Fig 3.
5. Position the decorative cover (E) on the wall and mark the locations for the hollow wall anchors. Pre-drill the holes for the hollow wall anchors and insert them into the wall as Fig. 4.
6. Place the mirror on the wall and secure it with the mounting screws (F) Fig 5. Note: IF NEEDED, REMOVE THE DECORATIVE KNOB(C) FOR ACCESSING TO THE MOUNTING SCREW AND PUT IT BACK WHEN IS DONE.
7. Put back the decorative cover (E) and secure by screwing the two set screws (D) as Fig 6.
8. The angle of the mirror is adjustable. Unscrew the decorative knob(C) and loosen the allen screw inside of the mirror stand offs with the allen wrench and adjust the angle you want. Then tighten the allen screw using the allen wrench, and screw back the decorative knob(C). Fig.2

Your installation is now complete

Fig.1

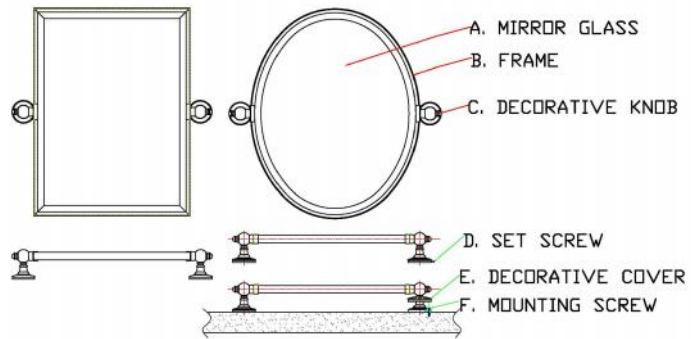

Fig.2

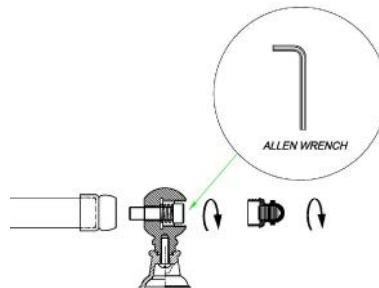

Fig.3

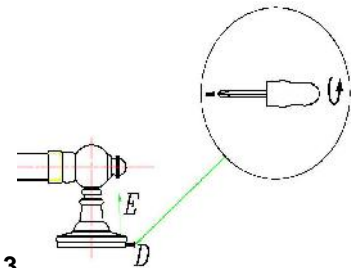

Fig.4

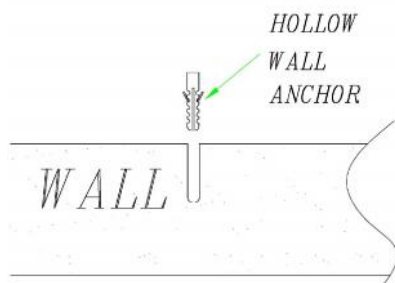

Fig.5

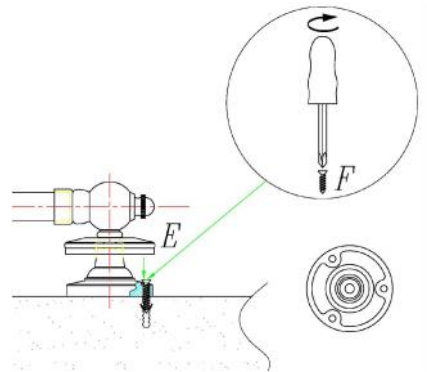

Fig.6

