

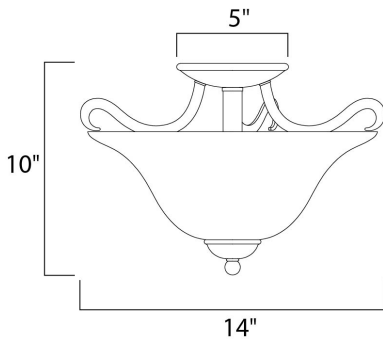

PRODUCT DESCRIPTION

Contemporary collection with sweeping arms and clean lines. Offered in Ice glass and Satin Nickel finish or Wilshire glass and Oil Rubbed Bronze finish.



MEASUREMENTS

DIMENSION : 14" L x 14" W x 10" H
 CANOPY : 5" W x 1" H x 5" L
 HANGING WEIGHT : 4.4 lb

LAMPING

INPUT VOLTAGE : 120V
 BULB : 2 x 60W Incandescent E26 Medium , 120W Total
 BULB INCLUDED : (Not Included)
 DIMMABLE : Yes

FINISHES OPTION

-  Oil Rubbed Bronze
-  Satin Nickel

GLASS

Frosted FT

MATERIAL

Steel, Glass

RATINGS

cETLus
 Dry Location



ADDITIONAL

OPERATING TEMPERATURE:
 -20°C (-4°F), 40°C (104°F)

Always consult a qualified electrician before installing any lighting product.



WESTERN DISTRIBUTION CENTER (HEADQUARTER)
 253 NORTH VINELAND AVE | CITY OF INDUSTRY, CA 91746

EASTERN DISTRIBUTION CENTER
 4200 SHIRLEY DR. | ATLANTA, GA 30336

P. 626.956.4200 | F. 626.956.4225 | maximlighting.com