



GERBER

Installation Instructions for Two-Piece Wall Hung Toilets



CAUTION: Product is heavy and may require handling by two people as it is fragile and breakable.



Recommended Tools, Materials, and Parts

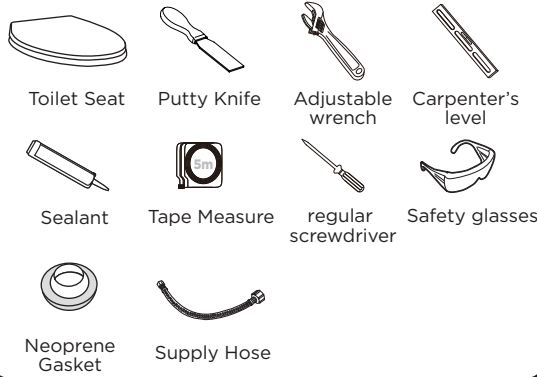

ADA compliant when installed 17" to 19" from the top of the seat to the floor

Required

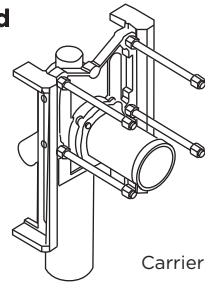

1. After installing the carrier

Measure thickness of VC flange and set the distance for the carrier bolts located in front of the wall, and adjust to 5/8" past VC.

3. Installing the bowl

Install and secure bowl using cap nuts supplied with wall-hung carrier.

2. Install Neoprene Gasket

Note: Please do not use a wax ring

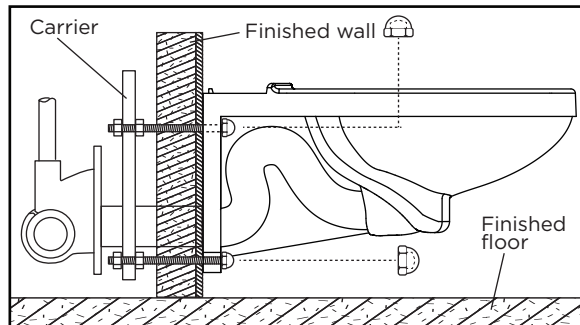
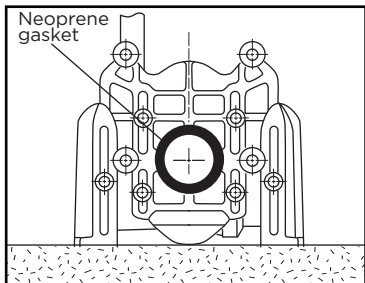

4. Installation for Gravity Tanks

1. Before assembling tank to bowl check tightness of lock nuts on both flush valve and fill valve.
2. Assemble tank bolts in tank with rubber washers and plastic wing nuts. Wing nuts should be tightened by hand sufficiently to compress rubber washers and insure water seal.
3. Assemble bevel washer to flush valve shank so that lock nut is enclosed in recess, making sure that the entire surface of the washer is in contact with the tank bottom.
4. Place two channel pads in recesses on back of bowl ledge to prevent china-to-china contact.

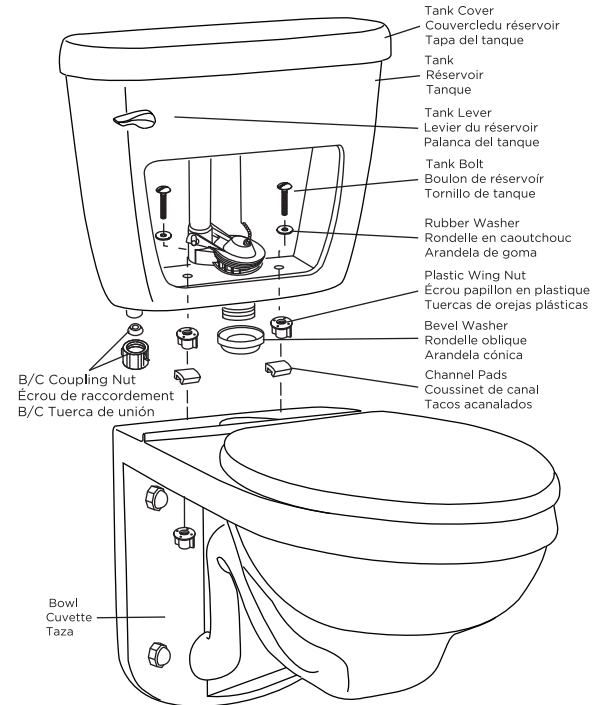

5. Place tank assembly in position. All parts are supplied. **USE NO PUTTY.** Plastic wing nuts are tightened by hand sufficiently to prevent rocking; and since the tank bolts are already sealed, the tank can be leveled by the relative amount that each wing nut is pulled down on the three points of contact...bevel washer and two channel pads.
6. The fill valve coupling nut is provided to connect the water supply line to the fill valve. **USE NO PIPE DOPE! HAND TIGHTEN ONLY! OVERTIGHTENING MAY SPLIT THE FILL VALVE AND WILL VOID THE WARRANTY!**
7. Adjust water level in tank to marked water line by adjusting water level screw.
8. Make sure refill tube is inserted into overflow tube.
9. Check action and nut tightness (left hand thread) of tank lever. Also, check looseness of chain (there should be slight slack in chain when at rest) and seal of flush valve flapper. Make sure tank lever is pushed down hard before making the chain adjustment.

WARNING:

DO NOT EXPOSE PLASTIC TRIM PARTS TO STRONG OXIDIZING AGENTS, CHLORINE, OR ACID LEVELS OF LOWER THAN 5-0 pH. USE OF SUCH AGENTS VOIDS THE MANUFACTURERS WARRANTY!

NOTE: TANK TYPE BOWL CLEANER CAN CAUSE TANK COMPONENT FAILURE AND DAMAGE. OUR WARRANTY EXCLUDES SUCH FAILURES.

4. Installation for Pressure Assist Tanks

1. Before assembling tank to bowl check tightness of lock nuts on both flush valve and inlet connection.
2. Assemble bevel washer to flush valve discharge extension so that lock nut is enclosed in recess.
3. Place two channel pads in recesses on back of bowl ledge to prevent china-to-china contact.
4. Place tank assembly in position, install plastic wing nuts and tighten, compressing bevel washer until contact is made tank to bowl at front and tank to channel pad in rear and no rocking occurs. **DO NOT OVERTIGHTEN.**

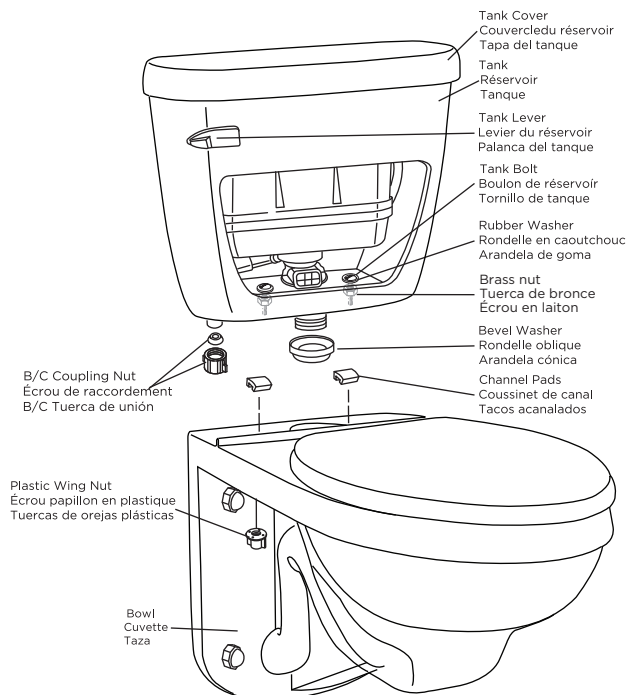

5. The water supply coupling nut is provided to connect the water supply to the water supply shank. **HAND TIGHTEN ONLY! OVERTIGHTENING MAY SPLIT THE INLET CONNECTION AND WILL VOID THE WARRANTY!**
6. When you turn the water supply on, you will hear water flow into the tank. When the flow stops (usually between 60 and 90 seconds), the flushometer/tank has filled and is ready to flush.
NOTE: Time must be allowed for this refill after every flush.
7. For best actuating performance, at rest there should be an approximate 1/16" gap between the actuator rod and the adjuster. If it is necessary to make this adjustment, it should be done with water supply attached and unit pressurized. Loosen set screw in top center and rotate adjuster to give the required gap and re-tighten set screw.

WARNING: DO NOT EXPOSE PLASTIC TRIM PARTS TO STRONG OXIDIZING AGENTS, CHLORINE, OR ACID LEVELS OF LOWER THAN 5-0 pH. USE OF SUCH AGENTS VOIDS THE MANUFACTURERS WARRANTY!

5. Connecting water supply

Connect the water supply line onto the water supply stop, and flush the line into a bucket before connecting to the fill valve at the bottom of the tank.

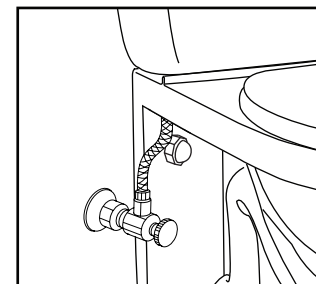

6. Checking the water level (for Gravity Tanks Only)

Turn the water on and let the tank fill up. Adjust fill valve for water level. Test flush two or three times and check for water leaks where the bowl is connected, by the supply lines, and where the tank is connected.

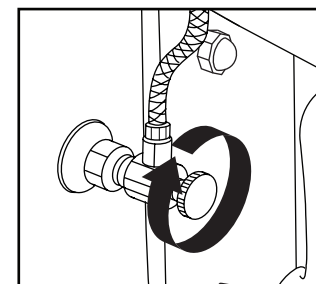

7. If leaking should occur

Check all of your connections to ensure all connections are secured and tightened properly.

Optional: Add sealant around the bowl carrier area after installation is completed.



GERBER

www.gerberonline.com