



ELEGANT

FURNITURE & LIGHTING™

Installation manual for:

V1800D16

Dimensions:D16” H20” L8

Collection:Primo

Bulb Type:E12 bulb not included

Lamp Frame Weight(lbs):16

Total Weight(lbs):28



Thank you for choosing our product(s).

Our Company is actively involved in every step of the production.

Our product(s) are designed to be utilized for every application that graces your home or business.

We pride ourselves in providing the most prompt and courtesy service to all of the valued customers.

Please find the enclosed detailed instruction and read carefully for proper installation.

If you have any questions, please contact the retailer where the purchased was made.



SAFETY

Warning: MAKE SURE THE ELECTRICITY TO THE WIRES YOU ARE WORKING ON IS SHUT OFF. BY EITHER REMOVING THE FUSE OR TURNING OFF THE CIRCUIT BREAKER.

CAUTION

- Before assembling the lighting fixture, please read all instructions carefully.
- All frame & crystal components are fragile, please handle with care.
- Required supply circuit : 110 - 130V/60Hz
- Labeled wires are "L" for live wire, "N" for neutral wire, "E" for ground wire.
- Never install fixture on damp ceiling, the room should be dry and well ventilated
- All electrical components must be installed by a licensed electrician and in accordance with the National Electrical Code and the appropriate local electrical codes.

Unpack the Package

Please open the box carefully and check all the items are inside the box. If you have any installation, assembling and missing parts questions, where you purchase from and any other relevant information ready, our customer service team will provide comprehensive and worry free service to our valued customers.

Frame Parts List

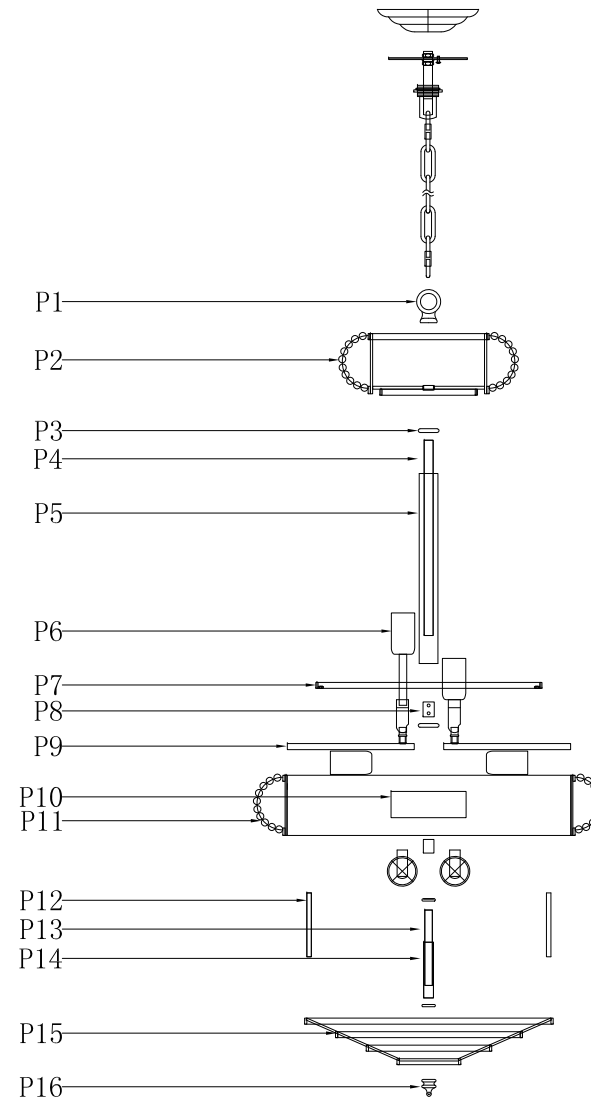









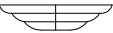













Step 1

Please use the parts list to ensure you are not missing any parts

V1800D16

PARTS LIST

| part | picture | Description | Parts Number | Qty | Check list |
|------|---|-------------------------------------|--------------|-----|------------|
| ZA |  | 4" Mounting bracket | CP10R53L3 | 1 | |
| ZB |  | 5.3" Canopy cover | | 1 | |
| ZC |  | Canopy ring | | 1 | |
| ZD |  | L59" CHAIN05T Twist Design | CHAIN05T | 1 | |
| ZE |  | Power Cord 12' SPT-1-18# Clear/Gold | | 1 | |
| P1 |  | Loop | | 1 | |
| P2 |  | Lamp body (1) | | 1 | |
| P3 |  | small cover | | 4 | |
| P4 |  | 10" Threaded pipe | | 1 | |
| P5 |  | 10" Metal tube | | 1 | |
| P6 |  | Socket | | 8 | |

| part | picture | Description | Parts Number | Qty | Check list |
|------|---|------------------------------|--------------|-----|------------|
| P7 |  | 12" Metal ring | | 1 | |
| P8 |  | Coupling Attach to the Frame | | 2 | |
| P9 |  | 6.7" Iron bracket | | 4 | |
| P10 |  | 4" Metal wire box | | 1 | |
| P11 |  | Lamp body (2) | | 1 | |
| P12 |  | 3.3" Iron bracket | | 4 | |
| P13 |  | 4" Threaded pipe | | 1 | |
| P14 |  | 3.1" Metal tube | | 1 | |
| P15 |  | 13" Bottom | | 1 | |
| P16 |  | Finial | | 1 | |
| A |  | 1050-14#*3pcs | | 92 | |
| B |  | 1050-14#*14pcs | | 28 | |
| C |  | 701-40# | | 61 | |

Step 2

Canopy Installation Instruction

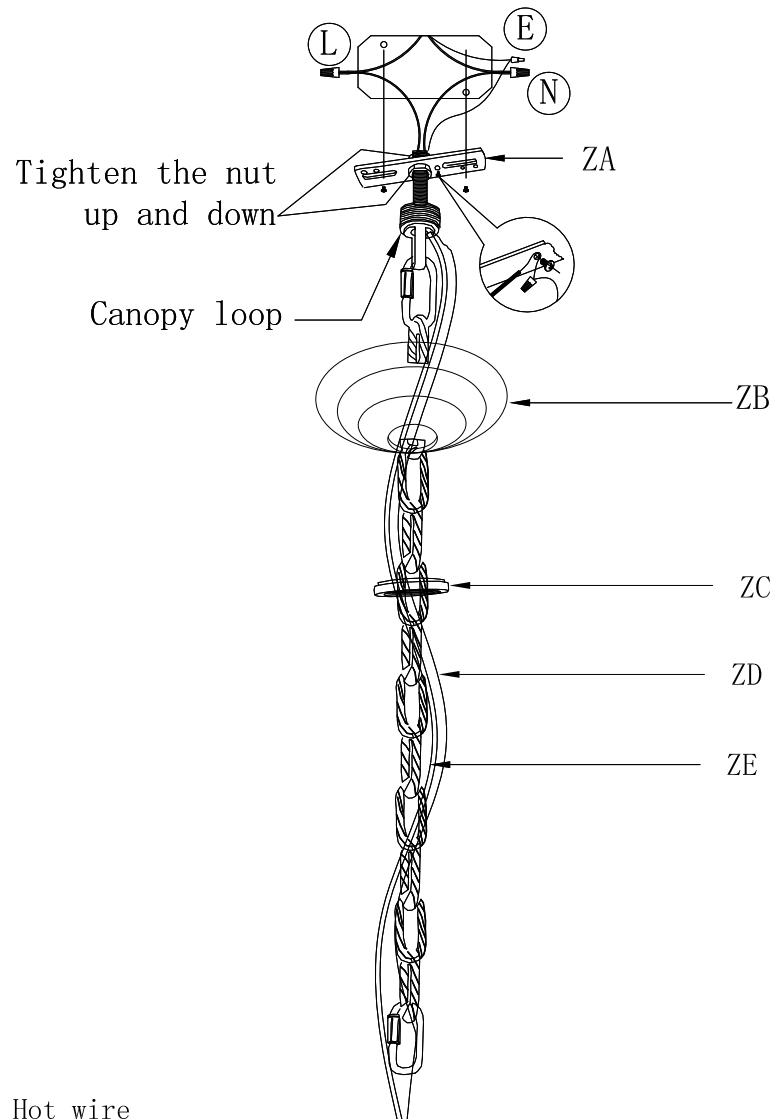

"L" = Hot wire
 "N" = Neutral wire
 "E" = Ground wire

05

IMPORTANT: Test sockets with bulb before dressing the fixture.

- 1 .Attach the crossbar to the electrical box.
- 2 .Pass the lamp wire and ground wire through the loop, canopy ring and center hole of canopy cover.
- 3 .Screw 2.5" threaded pipe into the crossbar and fasten with hex-nut.
- 4 .Pull wires up through the nipple.
- 5 .Screw loop only onto threaded pipe.
- 6 .Hang the fixture on chain.
- 7 .Make the electrical connections as detailed in the drawing above.
- 8 .Secure the canopy cover with threaded canopy ring

06

Frame Assembly Diagram

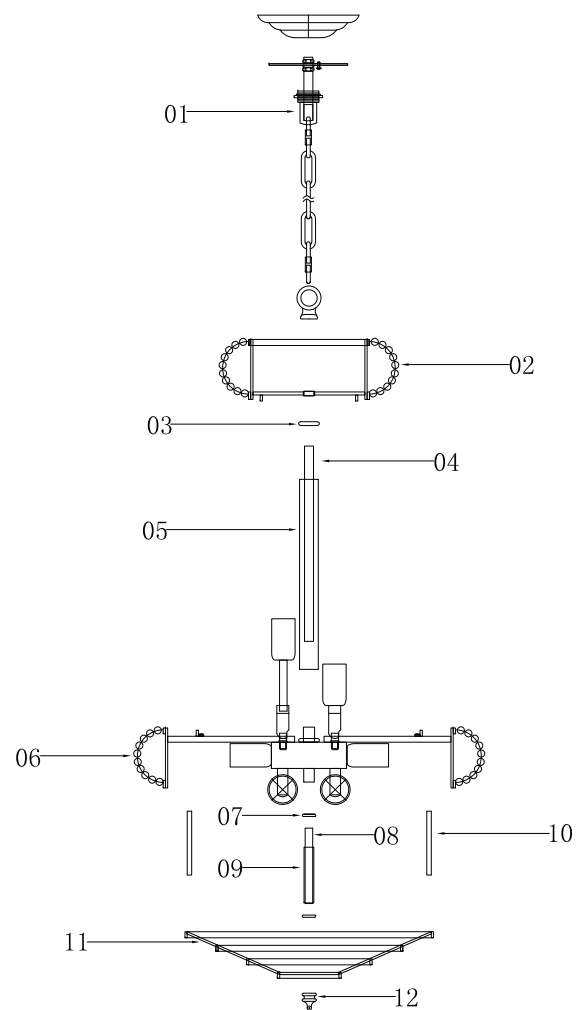

07

Step 3

Frame Assembly Instructions

Installation:

Please read all instructions carefully.

Before you proceed to install, make sure.

that the power supply is turned off and remains off until installation is complete.

Please note that each part has been assigned a number.

Please proceed in a numerical order.

1. Hang the chain (01) on the ceiling.
2. Screw threaded pipe (08) on the lamp body (06).
3. Screw iron bracket (10) on the lamp body (06) pressing holes with M3*12 screws, then screw bottom tier (11) on the iron bracket (10) pressing holes with M3*8 screws.
4. Install the small pipe cover (07) into the tier pipe (09) both sides, cover the tier pipe (09) on the threaded pipe (08), then pass the bottom tier (11), screw well with tower-shaped (12).
5. Pass the lamp body (06) main wire through the threaded pipe (04), top tier (02) and chain (01).
6. Screw threaded pipe (04) on the lamp body (06).
7. Install the big pipe cover (03) into the tier pipe (05) both sides, cover the tier pipe (05) on the threaded pipe (04), then pass the top tier (02), screw well with chain (01) bottom ring.
8. Hang the all lamp on the chain (01).
9. As the crystal pressing instruction, hang the crystal parts.

The end!

08

Step 4 Crystal Dressing Instructions

1. Hang crystal "A" "B" "C"

Crystal Dressing Diagram



When dressing the chandelier with the crystals please remember to wear either rubber or cotton gloves. So as to prevent any damage or smudging on the crystals.

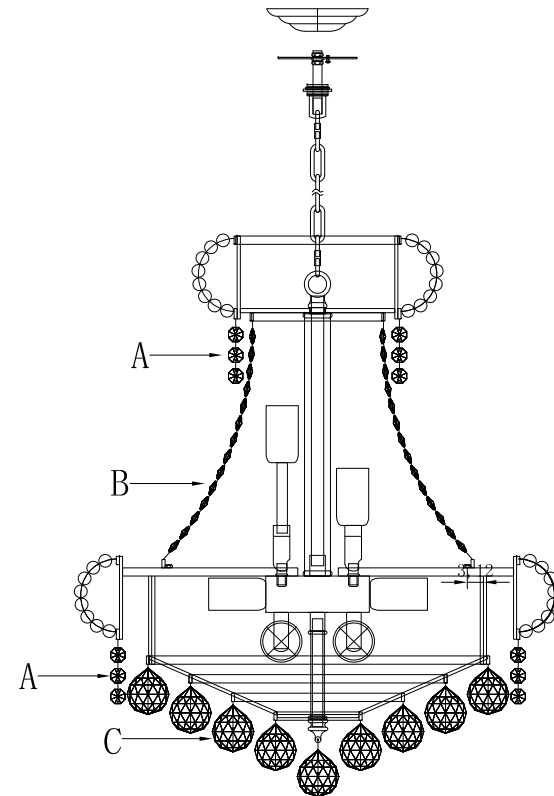

Congratulations !

You are now done installing your Elegant Lighting fixture. Sit back and admire each crystal as it will become the statement piece for your room/house.

Thank you.

Cleaning and Maintenance of Chandelier Frame

The finish on our chandelier frames and fixture frames is protected by a durable coating of lacquer. To clean, use a clean soft, dry cloth. Do not use any metal polishes, cleaners, abrasives or any substance which could remove the protective finish. Failure to follow these instructions automatically voids the guarantee.

Cleaning and Maintenance of Crystals

Wet a soft cotton fabric in clean warm water and wipe gently, then polish with a dry soft cotton fabric.

To Order Crystal Replacement Parts

Should you require replacement crystals or pins (the metal connectors attaching the crystals), contact the store where the product was purchased. For ease of ordering, you may use the original crystal trimming instructions provided with this product and circle the items you wish to order, indicating the quantity by writing the number needed adjacent to the circle. You will be contacted with prices prior to shipment. All orders must be pre-paid.

Elegant Lighting Warranty

The finish and frame of your new chandelier or fixture are warranted for a period of one (1) year from the date of purchase. Our company will, at its option, repair or replace any frame that has a defect in the materials or workmanship during the warranty period. All crystals are guaranteed for their original quality during the life of the chandelier. Breakage is not covered by this warranty.

To make a claim under this warranty, contact our customer service department.

A written return authorization form will be sent to you with specific instructions.

Returns and Conditions of Warranty

Returns must be pre-authorized by contacting the retailer where you made your purchase..Returns will only be accepted with a written return merchandise authorization and return shipping charges pre-paid. We reserve the right to inspect all returned merchandise to fully determine the nature of any defect. This guarantee shall not apply to any product that has been changed, altered or otherwise modified, nor shall it apply to any product that has been repaired or altered by anyone other than a pre-authorized facility. We will not be responsible for any breakage or damages incurred during transit, nor for crystal parts or metal frame part that have been subject to misuse, negligence, accident or inappropriate handling. Also, we will not be held responsible for damage incurred during improper installation or wiring by others, nor for damages resulting from a failure to follow the recommended maintenance or installation procedures. This guarantee is issued in lieu of any and all other guaranteed or warranty, whether written or implied and any and all other obligations or liabilities. Further, we neither authorize nor permit any other person or firm to assume for us, any liability in connection with the sale of our products.