



ETRE™

30" X 20" SINGLE BOWL APRON KITCHEN SINK



D21180SB3020.415

FEATURES

- Fine fire clay construction with heritage styling and clean apron design
- Finished on all 4 sides
- Offset drain
- Undermount or flush mount installation
- Protective stainless steel bottom grid and drain included
- 33" (838 mm) cabinet required
- 5 year limited warranty on sink; 1 year on included accessories
- Sink can accept a garbage disposal but requires an extended disposal flange (both sold by others)

DIMENSIONS

NOMINAL DIMENSIONS

29-3/4" x 20" x 10" (755 x 508 x 254 mm)

BOWL INSIDE DIMENSIONS

29-3/4" (716 mm) wide

18-7/16" (468 mm) front to back

8-3/4" (223 mm) depth

COLORS/FINISHES

Canvas White (415)

COMPONENTS

7302389-401 Sink Rack

7301839-201 Drain with Strainer

COMPLIANCE CERTIFICATIONS

Meets or Exceeds ASME A112.19.2 / CSA B45.1

ROUGH-IN DIAGRAM SHOWN
ON NEXT PAGE



ETRE™

30" X 20" SINGLE BOWL APRON KITCHEN SINK

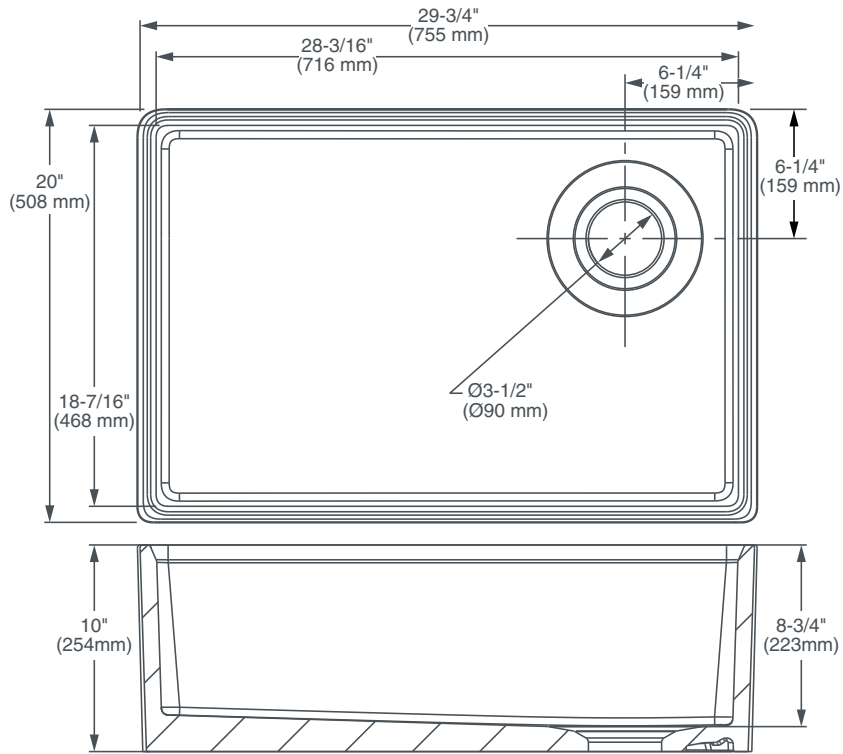

NOTES:

Refer to installation instructions supplied with kitchen sink for undermount, countertop or above counter custom installations.

Due to the fireclay process, dimensions may vary. Please use the actual sink that you will be installing in order to determine the cutout dimensions for your countertop.

CAUTION: Sink is heavy! Installer must provide adequate reinforcement for all load-bearing supports in accordance with installation instructions supplied with kitchen sink.

Fittings not included with fixture and must be ordered separately.

IMPORTANT:

Dimensions of fixtures are nominal and may vary within the range of tolerance established by ANSI standards.

These measurements are subject to change or cancellation. No responsibility is assumed for use of superseded or voided pages.

PART OF LIXIL