



Features

- Available in 28 finishes including 13 PVD finishes
- All brass construction
- Single handle allows for volume & temperature control at any position
- 1.2gpm (4.5 L/min) max flow rate
- Rough valve (SHV-R) sold separately



TO-VE501-7-SN shown



Codes/Standards Applicable

Product meets or exceeds the following:

- ASME A112.18.1/CSA B125.1
- NSF 61, NSF 372, CEC & DOE
- EPA WaterSense
- Commonwealth of MA
- ADA compliant

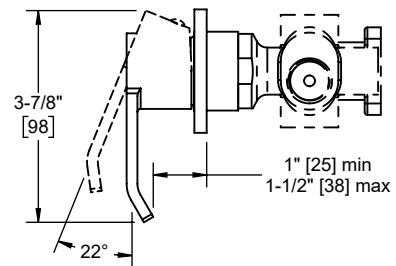
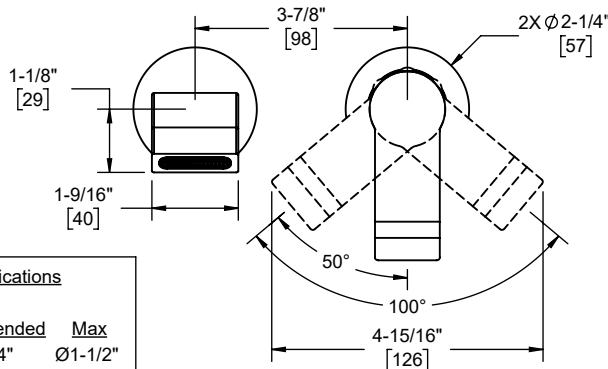
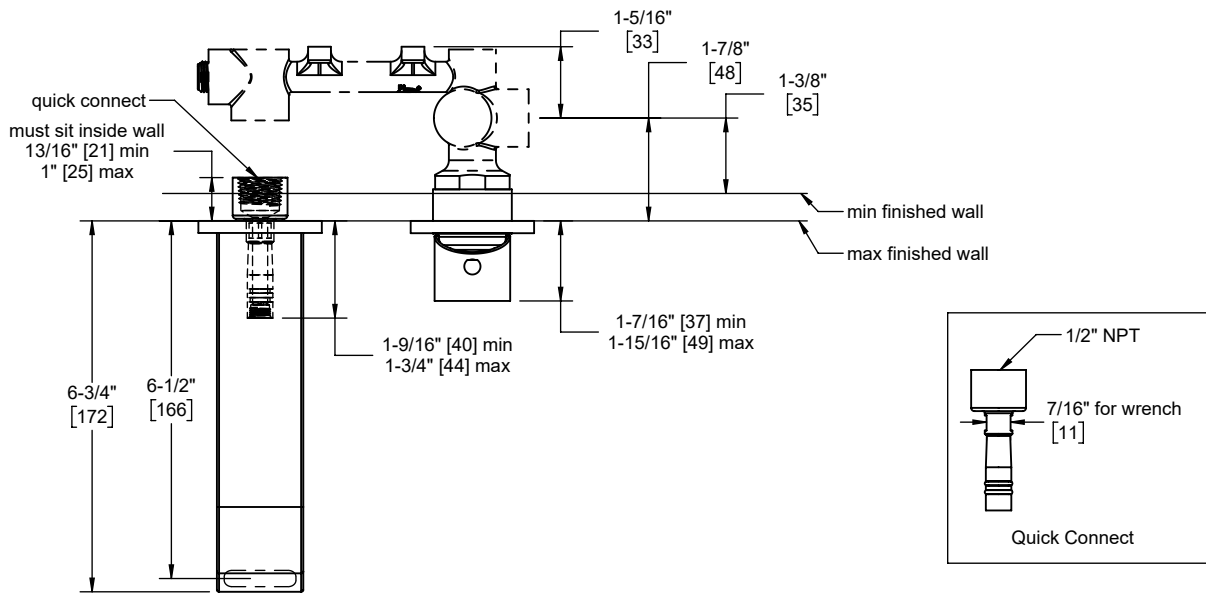

Through-Hole Specifications

	Min	Recommended	Max
Spout: Ø	1-1/4"	Ø1-1/4"	Ø1-1/2"
	[32]	[32]	[38]
Handle: Ø	1-5/8"	Ø1-3/4"	Ø2"
	[41]	[44]	[51]

Specifications subject to change without notice

Dimensions are inches, rounded to 1/16"
[Dimensions in brackets are mm, rounded to 1mm]