

***** READ & SAVE THESE INSTRUCTIONS *****
MODEL: 20624 / 20625 / 20626
(INSTALLATION & OPERATION

(1) TOOLS AND MATERIALS REQUIRED

- ❖ BLADE & PHILIPS SCREW DRIVER
- ❖ ADJUSTABLE WRENCH
- ❖ STEP LADDER
- ❖ WIRE CUTTERS
- ❖ WIRING SUPPLIES AS REQUIRED BY ELECTRICAL CODE
- ❖ 1/2/3 X A-19/60W/75W/100W LAMP(MODEL DEPENDANT)

Attention:

Before assembling your lighting fixture, please read the following instructions. If you feel you do not have sufficient electrical experience, refer to a do-it-yourself wiring handbook or have your fixture installed by a qualified licensed electrician.

(2) GENERAL

1. To ensure the success of the installation, be sure to read these instructions and review the diagrams thoroughly before beginning.
2. All electrical connections must be in accordance with local codes, ordinances, or the National Electrical Code. If you are unfamiliar with methods of installing electrical wiring, secure the services of a qualified licensed electrician.
3. These fixtures are intended for mounting to a standard 4" x 2 1/4" deep metal octagon J-box. The box must be directly supported by the building structure and U.L. recognized.
4. Before commencing with the installation, disconnect the power by turning off the circuit breaker or by removing the fuse at the fuse box. Turning the power off using the light switch is not sufficient to prevent electrical shock.

NOTE:

The important safeguards and instructions appearing in this manual are not meant to cover all possible conditions and situations that may occur. It must be understood that common sense, caution and care are factors that cannot be built into any product. These factors must be supplied by the person(s) caring for and operating the fixture.

(3) UNPACKING THE FIXTURE

- On checking the contents of the box you will find:
- ❖ Mounting Hardware Package
 - ❖ Glass Diffuser
 - ❖ Fixture Assembly

(4) PREPARING THE FIXTURE

Refer to figure 1 for illustration of fixture parts and assembly.

1. If you are replacing an existing fixture, disconnect and remove the old fixture. Expose the supply wiring from the J-box.
2. Attach the supplied screws to the crossbar and fasten the crossbar to the J-box with supplied screws.
3. Attach the ground wire from the fixture to the J-box ground terminal (or to the box ground wire). secure both the fixture ground wire and the box ground wire directly with the supplied wire connector. connect the fixture wires to the appropriate electrical supply wires from the J-Box using the supplied wire connectors secure wire connectors with UL listed electrical tape. Tuck wires carefully into J-Box.
4. Position the fixture over the protruding threaded screws fixture retaining screws twist the fixture to ensure that the narrow part of the keyhole is over the screw head and tighten the screws.
5. Insert your light bulbs making sure that you do not exceed the max recommended wattage as per the label attached to the fixture.
6. Position the Glass Shade over the pan and gently twist the Glass Shade in a clockwise direction.

CAUTION:

Mounting the Glass

Align the glass such that the three protruding portions of the metal base lip are positioned in the three flat areas of the glass rim. Now turn the glass in a clockwise direction, so that the protrusions move into the narrowing groove on the glass rim. **DO NOT FORCE GLASS.** Glass is secure when there is no gap between the metal base and the glass. Over tightening of the glass may result in the glass being extremely difficult to remove when replacing lamps.

7. Restore electricity and check the operation of your new lighting fixture.

PLEASE SEE DIAGRAM ON REVERSE SIDE OF PAGE.

access
LIGHTING

FIGURE

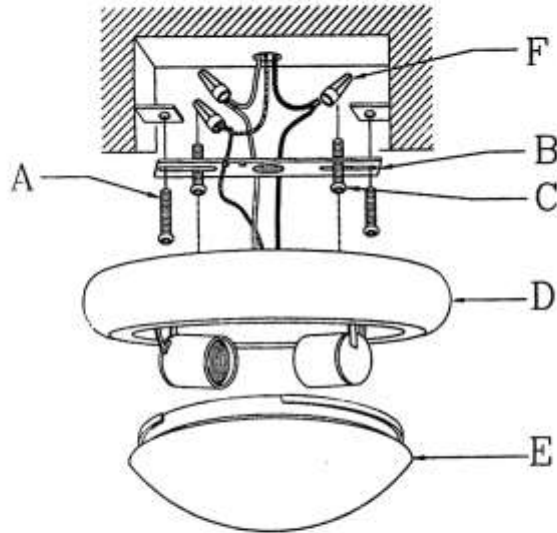

A. Screw 2pcs

B. Crossbar

C. Screw 2pcs

D. Canopy

E. Glass shade

F. Wire connector 3pcs

access
LIGHTING

103606-01-1